

Original installation and operation manual

CLEARPOINT® V activated carbon filter with cartridge

> S055

> M010X

> M018

■ Table of contents

1. General	4
1.1 Contact	4
1.2 Information regarding installation and operation manual	4
1.3 Other applicable documents	4
1.4 Explanation of the symbols and pictograms utilised	5
1.4.1 In the documentation	5
1.4.2 On the device	6
1.5 Intended use	7
1.6 Reasonably foreseeable inappropriate use	8
1.7 Legal warranty and liability for property defects	8
1.8 Target group and personnel	9
1.9 Responsibility of the operating company	9
2. Safety-related information	10
2.1 General instructions	10
2.2 Safety instructions	11
3. Transport and storage	12
4. Product information	13
4.1 Product description	13
4.2 Product overview	14
4.3 Product identification	15
4.4 Function description	17
4.4.1 Adsorption	17
4.4.2 Oil indicator	17
4.5 Scope of delivery	19
4.6 Type plate	20
4.7 Maintenance label for cartridge replacement	21
5. Technical data	22
5.1 Filter performance data	22
5.2 Materials	23
6. Dimensions	24
7. Assembly	26
7.1 Warning notices	26
7.2 Assembly work	27
8. Commissioning	29
8.1 Commissioning tasks	29
9. Maintenance and servicing	30
9.1 Maintenance schedule	30
9.2 Cleaning	30
9.2.1 Warning notices	30
9.2.2 Cleaning work	31
9.3 Visual inspection	31
9.4 Replacement of the testing tube	31
9.5 Cartridge replacement	32
9.13 Leakage test	36
10. Decommissioning	37
11. Disassembly	38

11.1	Warning notices	38
11.2	Dismantling work.....	39
12.	Disposal	41
12.1	Warning notices	41
12.2	Disposal work	41
13.	Spare parts and accessories.....	42
13.1	Spare parts	42
13.2	Accessories attachment components top	43
13.3	Accessories attachment components bottom.....	44
14.	Troubleshooting / FAQ.....	45
15.	Approval certificates and declarations of conformity	46

1. General

1.1 Contact

Manufacturer	Customer service and tools
BEKO TECHNOLOGIES GmbH Im Taubental 7 D-41468 Neuss Tel. + 49 2131 988 - 1000 info@beko-technologies.com www.beko-technologies.com	BEKO TECHNOLOGIES GmbH Im Taubental 7 D-41468 Neuss Tel. + 49 2131 988 - 1000 service-eu@beko-technologies.com www.beko-technologies.com

1.2 Information regarding installation and operation manual

INFORMATION	Copyright protection!
	The contents of the installation and operation manual in the form of text, figures, illustrations, photographs, technical drawings, diagrams and other representations are protected by the copyright of the manufacturer. This applies especially to duplication, reproduction, microfilming and storage as well as processing in electronic systems.

Publication date	Revision status	Reason for amendment	Scope of amendment
19 September 2019	00_01	Changes to standards and regulations	Completely new version

The installation and operation manual, hereinafter referred to as the manual, must always be kept close to the product and be in a permanently legible condition.

The manual must be handed over along with the product if it is sold or passed on.

NOTE	Follow the instructions given in the manual!
	This manual contains all the basic information required for safe operation of the product and must therefore be read before any actions are performed. Otherwise personal and material hazards as well as functional and operational malfunctions are possible.

1.3 Other applicable documents

This manual contains all the necessary steps for installation and operation of the CLEARPOINT® V activated carbon filter with cartridge.











More detailed information about the installation and operation of the accessories is contained in the following installation and operation manuals:

- CLEARPOINT® oil indicator



1.4 Explanation of the symbols and pictograms utilised

The symbols and pictograms utilised below indicate safety-relevant and important information which must be adhered to when handling the product and to ensure safe and optimum operation.

1.4.1 In the documentation

Symbol/Pictogram	Description/Explanation
	General hazard symbol (danger, warning, caution)
	Pressurised system
	Note the installation and operation manual
	General note
	Wear respiratory protection FFP 3
	Wear safety footwear
	Wear protective gloves (fluid-resistant)
	Wear hearing protection
	Wear safety goggles with side shields
	General information

1.4.2 On the device

Symbol/Pictogram	Description/Explanation
	General hazard symbol (danger, warning, caution) (This symbol can be found on the type plate and on the maintenance label for cartridge replacement.)
	Note the installation and operation manual
	Maintenance label for cartridge replacement When the next scheduled cartridge replacement is due is marked on this adhesive label, and that the installation and operation manual should be followed.

1.5 Intended use

CLEARPOINT® V activated carbon filter with cartridge and accessories

The CLEARPOINT® V activated carbon filter with cartridge, also referred to as filter below, is used for the adsorption of aerosols and adsorption particles in compressed gas systems.

Any use of this system other than the use described in this manual is hereby deemed to be non-intended and can cause a hazard for the safety of people and the environment.

- Only use filters and accessories within the operating parameters given in the technical data and the agreed delivery conditions.
- Only use filters and accessories within a pipeline system designed for the technical data with appropriate connections, pipe diameters and assembly clearance.
- Only use the filters and accessories for the treatment of compressed gases of fluid group 2 according to Pressure Equipment Directive 2014/68/EU which are free of aggressive and corrosive components.
- Only use filters and accessories in non-explosive hazardous areas.
- Only use filters and accessories away from direct solar radiation and heat sources as well as areas subject to frost.
- Only combine the filters and accessories with the products named and recommended by **BEKO TECHNOLOGIES GMBH** in the manual.

Before using the filters, the operating company must make sure that all conditions and prerequisites for intended use are given.

The filter is exclusively designed for stationary use in a commercial or industrial area. All the assembly, installation, operation, disassembly and disposal work described may only be performed by qualified skilled personnel.

1.6 Reasonably foreseeable inappropriate use

Reasonably foreseeable inappropriate use is deemed to have occurred if the filter or any accessories are used in any other way than that described in the chapter "Intended use". Reasonably foreseeable inappropriate use includes the use of the product in a manner not intended by the manufacturer or supplier but which may result from foreseeable human behaviour.

Reasonably foreseeable inappropriate use includes:

- Executing of modifications of all kinds, in particular design and process engineering interventions, as these can lead to personal injury and damage to property as well as malfunction and device failure.
- The overriding, bridging or non-application of existing or recommended safety devices.
- The use for treatment of compressed gases which are not included in fluid group 2 in accordance with PED 2014/68/EU or contain aggressive components. In cases of doubt a gas/condensate analysis must be carried out.

This list is not exhaustive as not all possible inappropriate use can be foreseen in advance. If the operating company is aware of any inappropriate use of the filter or accessories which are not listed here, the manufacturer must be informed immediately.

1.7 Legal warranty and liability for property defects

The operating company and operator must take into account the intended use. The operating company will be completely liable for every not described action and utilisation which exceeds the stated intended use.

All liability or warranty claims will be invalidated insofar as the filter is not operated according to the intended use or is operated outside the limits specified in the technical data.

This includes:

- incorrect technical installation, commissioning, servicing, maintenance or operation
- the use of defective components
- non-compliance with the safety-relevant information, action steps and instruction contained in this manual
- the performance of any kind of modification, in particular constructive and process technology interventions on the product
- the use of third-party spare parts or accessories, which have not been approved by the manufacturer, during maintenance and repair work
- Non-compliance with servicing, maintenance and inspection intervals

1.8 Target group and personnel

This manual addresses the skilled personnel listed below who are involved with work on the filter or the accessories.

INFORMATION	Personnel requirements
	<p>The personnel may not execute any actions on the filter or the accessories when they are under the influence of drugs, medications, alcohol or other substances that may impair their consciousness.</p>

Skilled personnel - transport and storage

Skilled personnel - transport and storage are people who, due to their training, professional experience and qualifications, have all the necessary skills to safely execute all actions in connection with the transport and storage of the product, to instruct, to recognise possible dangerous situations independently and to execute measures to avoid danger.
 The capabilities include, in particular, experience with hoists, forklifts and lifting equipment and knowledge of local laws, standards and guidelines relating to transport and storage.

Skilled personnel - compressed gas technology

Skilled personnel - compressed gas technology are people who, due to their training, professional experience and qualification, possess all the necessary capabilities to safely execute actions, and instruct all actions related to compressed gases and pressurised systems, to independently foresee potential hazardous situations and implement appropriate measures to avert any danger.
 The capabilities include, in particular, experience in handling measurement and control technology as well as knowledge of the regionally applicable laws, standards and regulations for compressed gas technology.

1.9 Responsibility of the operating company

The responsible operating company must ensure the following to prevent accidents, incidents and adverse effects on the environment:

- Before all actions, check to ensure that the manual available does in fact belong to the product.
- Always use, maintain and service the product properly.
- All applicable statutory requirements, safety regulations and accident prevention regulations have been adhered to.
- All regulations and operation manual for safe working and information regarding behaviour in the event of accidents and fires at the operating location are accessible to personnel at all times.
- The product is used with recommended and functioning safety devices that are not overridden.
- Always have assembly, installation and maintenance work carried out by qualified skilled personnel only.
- Personnel have the recommended personal protective equipment at their disposal and it is used.
- Appropriate technical safety measures have been implemented to ensure that the permissible operating parameters are not exceeded or undershot.

2. Safety-related information

2.1 General instructions

Safety instructions warn against residual risks when handling the product. Warning notices in the instructional text precede the procedure that poses a hazard to personnel or the environment.

These safety and warning notices must be strictly observed in order to prevent accidents, personal injury, damage to property and impairments during operation.

Structure of the safety instructions

The content of the safety instructions is based on the **SAFE principle**:

- S - Safety symbol and signal word
- A - Type and source of danger
- F - Possible consequences of disregarding the danger in the order of its severity
- E - Measures to prevent danger

Structural design of the safety instructions:

SIGNAL WORD	Type and source of danger!
 Safety symbol	Possible consequences if the danger is ignored
	<ul style="list-style-type: none"> • Measure to prevent the danger





Signal words according to ISO 3864 and ANSI Z.535.6

DANGER	Imminent hazard Consequences of non-compliance: Death or serious personal injury
WARNING	Imminent hazard Consequences of non-compliance: Death or serious personal injury are possible
CAUTION	Potential danger Consequences of non-compliance: injury and/or damage to property
NOTE	Additional notes, information, tips Consequences of non-compliance: Disadvantages during operation, actions and maintenance. No danger to people or regarding the safe operation.



2.2 Safety instructions

In order to prevent accidents, personal injury and damage to the device as well as impairments during operation, it is essential to adhere to the specified safety and warning notices.

The personal protective equipment specified in the safety instructions must be selected and made available by the operating company depending on the system parameters and properties.

DANGER	Operation of plant outside the permissible limit range!
	<p>Operation of the product outside the permissible limits and operating parameters, unauthorised intervention and modifications may result in death or serious injury.</p>
	<ul style="list-style-type: none"> • For safe operation of the product, always adhere to the limit values, operating parameters and maintenance intervals as well as the set-up and ambient conditions specified on the type plate and in the manual. • Inspect whether the operating parameters have been amended or restricted by the use of accessories. • Only use the product for its intended use.
DANGER	Pressurised system!
	<p>Death or serious personal injury can result through contact with fast or suddenly escaping compressed air or through bursting system parts</p>
	<ul style="list-style-type: none"> • All work on the system must be carried out in the depressurised state and with the system secured against unintentional pressure build-up. • Set up a safety zone around the system during all assembly, installation, maintenance and repair work. • Before applying pressure to the system, check all pipe connections and tighten if necessary. • Slowly pressurise the system with compressed gas. • Avoid pressure blows and high differential pressures. • Assemble all pipes without mechanical stress. Avoid any vibrations occurring in the pipe network by using vibration dampers. • Always keep exactly to the installation and operating instructions given in this manual. • Always keep inspection and maintenance interval exactly. • Install fixed pipes as supply and discharge pipes. • Do not carry out any structural changes to the product.
DANGER	Use of incorrect spare parts, accessories or installation materials!
	<p>The use of incorrect spare parts, accessories or installation materials, as well as auxiliary and operating materials, may result in death or serious injury. In addition, malfunction and device failure or material damage can occur.</p>
	<ul style="list-style-type: none"> • For all installation, servicing and maintenance work, only use undamaged original parts, auxiliary and operating materials which are specified by the manufacturer. • Only use fittings and connecting elements approved for the respective application as well as suitable tools in perfect operating condition. • Only use cleaned pipes that are free of dirt and corrosion.
WARNING	Non-application of personal protective equipment!
	<p>Non-application of personal protective equipment or the use of sub-standard protective equipment can lead to accidents or personal injuries during work on the product.</p>
	<ul style="list-style-type: none"> • The personal protective equipment recommended, which must be in a flawless condition, must be worn during all work on the product. • Inspect the personal protective equipment regularly for flawlessness and functionality and replace damaged parts immediately.
WARNING	Insufficient qualification!
	<p>Insufficient qualification of the personnel can lead to accidents, personal injury and damage to the device as well as impairments during work on the product.</p>
	<p>All work on the product may only be carried out by appropriately qualified skilled personnel.</p>

3. Transport and storage

WARNING	Insufficient qualification!
	<p>Insufficient qualification of the personnel carrying out work on the product and accessories can lead to accidents, personal injury and damage to property as well as impair operation.</p> <ul style="list-style-type: none"> The work on the product and accessories described below may only be executed and documented by skilled personnel - transport and storage.
CAUTION	Inappropriate transport or storage!
	<p>Inappropriate transport or storage may result in personal injury or damage to the device.</p> <ul style="list-style-type: none"> Wear protective gloves when working with packaging material Use personal protective equipment, inspect it regularly for faultlessness and functionality and replace damaged parts immediately. Handle packaging and product with care. Pack all parts impact-proof using suitable material. Transport and handle the packaging according to the markings (observe lifting gear attachment points, the centre of gravity and orientation e.g. keep vertical, do not throw etc.). Use proper means of transport and lifting equipment that is in proper working order. Always adhere to the specified transport and storage parameters. Store the product only outside of areas exposed to direct sunlight and heat sources.

Permissible storage and transport conditions, refer to “5. Technical data” on Page 22.

NOTE	Handling packaging material!
	<p>Inappropriate disposal of packaging materials can cause environmental damage.</p> <ul style="list-style-type: none"> The packaging material is recyclable. Dispose of the packaging material in accordance with the regional laws, provisions, guidelines and regulations of the country and place of use.

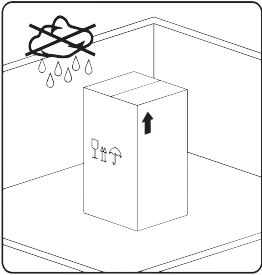
NOTE	Note for transport and storage!
	<p>The product must be</p> <ul style="list-style-type: none"> stored in the original packaging and retained in a dry as well as frost-free room. The ambient conditions, transport and storage parameters must never fall short of or exceed the specifications in the technical data chapter. Always protect it against external weathering effects even in a packaged condition. Secure the plant so that it cannot topple over or fall and protect it against vibration at the storage location.

4. Product information

4.1 Product description

The CLEARPOINT®V activated carbon filters with cartridge are exclusively used to separate residual oil contents in steam and aerosol form from compressed air and nitrogen in pressurised systems.

The compressed air must not exceed a humidity content of 30 % and a temperature of +35 °C. Exceeding these values reduces the service life of the activated carbon filter with cartridge. The use of an adsorption or refrigeration dryer before the inlet is recommended. The service life of the cartridge is extended in relation to the dryness of the air at the inlet.

With corresponding sizing and adherence to the nominal operating parameters, the oil content of the incoming compressed air is reduced by the activated carbon in the activated carbon filter. Life expectation and dimensioning depends on the following parameters:

- Temperature of the compressed air
- Operating pressure of the compressed air
- Volume flow of the compressed air
- Relative humidity of the compressed air
- The oil used
- The compressor design

Changes in operating conditions lead to a reduction in the service life of the activated carbon filter:

- Increasing the volume flow rate
- Increasing the operating pressure
- Increasing the relative humidity of the compressed air
- Increasing the residual oil aerosol content at the inlet.

Depending on the quality of the compressed air in the supply network, a preliminary filter and at least one refrigeration dryer are required for the incoming compressed air. The preliminary filter ensures that the oil aerosol content of the incoming air does not exceed the value 0.01 mg/m³. Use of a refrigeration dryer guarantees the maximum permissible humidity of the compressed air of 30% at the inlet to the activated carbon filter.

4.2 Product overview

The filter is made up of the following components:

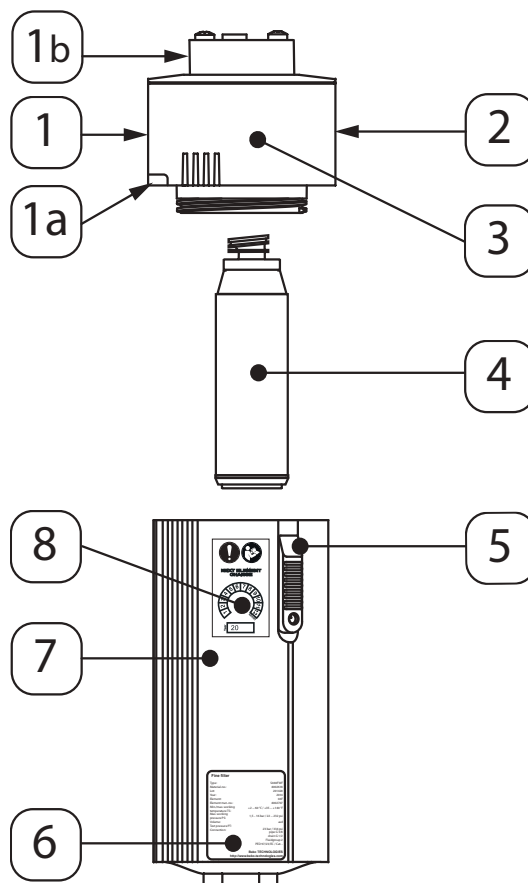

Position no.	Explanation/description
[1]	Inlet at the filter head
[1a]	Tactile feature for identifying the inlet
[1b]	Adapter for use of the oil indicator of differential pressure gauge
[2]	Outlet at the filter head
[3]	Filter head
[4]	Activated carbon cartridge
[5]	Safety slide with locking screw
[6]	Type plate
[7]	Filter housing with internal sealing ring
[8]	Maintenance label for cartridge replacement

4.3 Product identification

The product designation is shown on the type plate and made up of numbers and letter codes. Each code stands for a filter component and is divided into the following categories:

- [1] = Size: Housing
- [2] = Cartridge
- [3] = Attachment components top
- [4] = Attachment components bottom

The product designation is explained below using the example “S055VWM”:

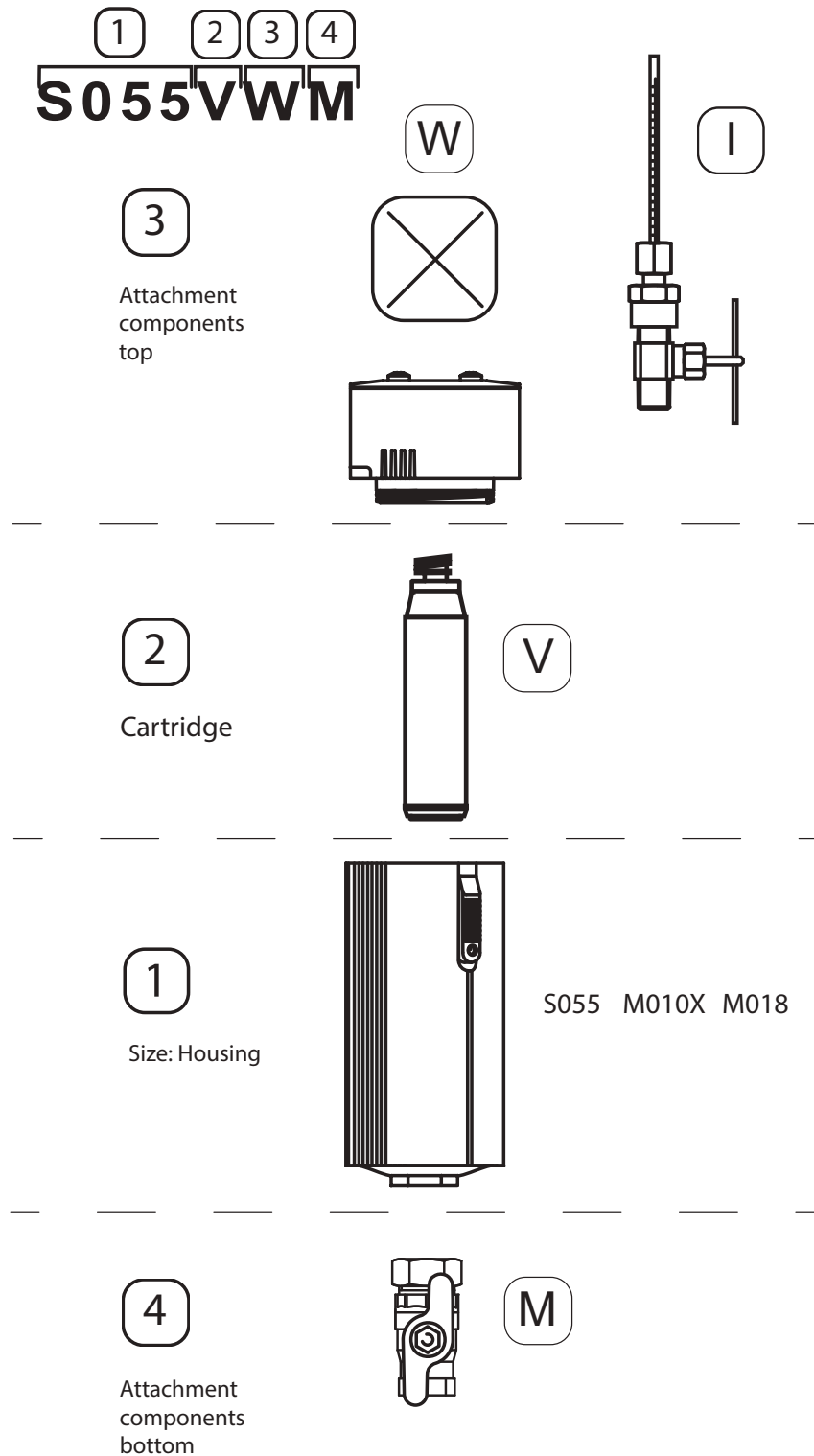

Attachment components top			
Position no.	Letter code	Designation	
[3]	I	Oil indicator	
	W	Without indicator unit	
Position no.	Housing size	Cartridge	
[2]	S055	06V	
	M010X	10V	
	M018	18V	
Position no.	Model series	Construction size	Designation
[1]	S	055	Filter housing
	M	010X	
	M	018	
Attachment components bottom			
Position no.	Letter code	Designation	
[4]	M	Manual condensate drain	

4.4 Function description

4.4.1 Adsorption

With the CLEARPOINT® V activated carbon filter with cartridge, the flow through the filter element is from top to bottom: The compressed gas enters from above through a small filter element that separates coarse particles. Compressed gas flows from above into the inner area of the cartridge and from there through the cartridge into the vessel. The activated carbon in the adsorption material adsorbs oil vapours and odours.

The cartridge service life depends among other things on the oil content of the compressed gas, since the adsorber material can only absorb a limited volume of oil vapours and odours.

An oil indicator can be used to determine how charged the cartridge is with aerosols.

More detailed information can be found in the installation and operation manual for the oil indicator.

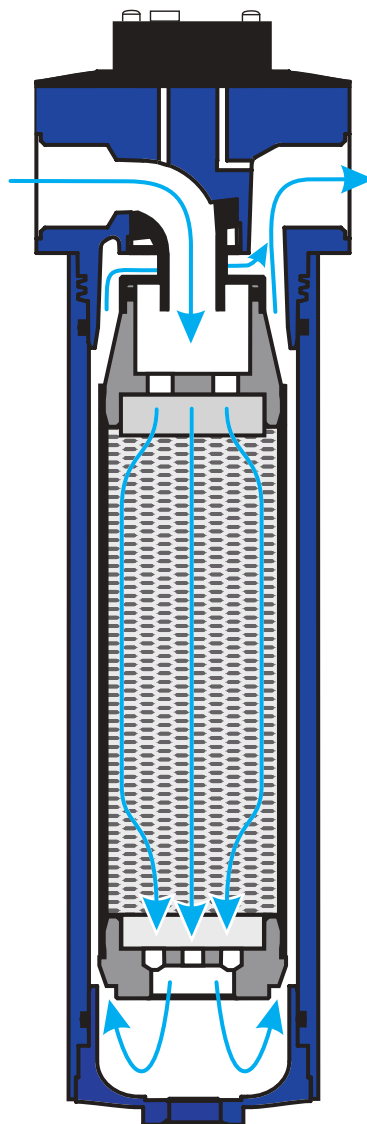

4.4.2 Oil indicator

The oil indicator can be ordered as an accessory.

Either the oil indicator or a differential pressure gauge can be screwed onto the adapter.

An adapter [1] with the oil indicator can be screwed onto the filter head [A] to measure and evaluate the quality of the compressed gas. For measurement, a partial flow [C] of the compressed gas flow at outlet [B] is routed through a channel towards the testing tube [5] and then discharged into the environment.

The oil indicator has a built-in pressure reducer [2] which reduces the operating pressure required for measurement down to 7.0 bar(g). For the measurement, the needle valve [3] must be fully open. Then a defined partial compressed gas flow of 2- 3 l/min at 7.0 bar(g) passes through the testing tube [5].

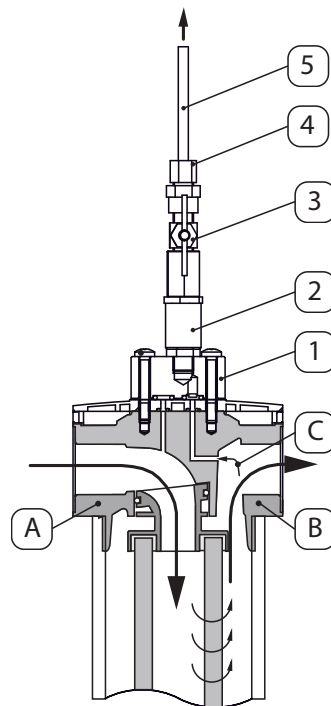

The oil contained in the compressed gas results in a progressively red discolouration of the testing tube from bottom to top [5]. If the testing tube has completely changed its colour, it must be replaced. For further information, please refer to the installation and operating instructions enclosed with the oil indicator.



Position no.	Explanation/description
[1]	Adapter
[2]	Pressure reducer
[3]	Needle valve
[4]	Screw attachment with seal
[5]	Testing tube
[A]	Filter head
[B]	Output
[C]	Partial flow

4.5 Scope of delivery

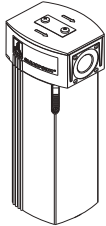
The following table shows the scope of delivery of the filter.

Figure	Description/Explanation
	<p>Activated carbon filter with cartridge</p>
	<p>Installation and operating manual</p>

INFORMATION	Possible product combinations!
	<p>The scope of delivery can vary depending on the product combination.</p>

For further information on possible product combinations see “4.3 Product identification” on Page 15.

4.6 Type plate

The type plate contains the identification and operating parameters of the filter and is located on the housing. If you contact the manufacturer or supplier, always have this data ready for system identification.

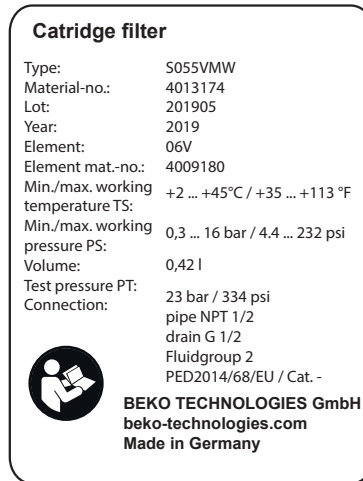

Example:

Position on type plate	Description
Cartridge filter	BEKO filter designation
Model:	Sales designation
Material no.	Material number
Lot	Lot number
Year	Year of manufacturer
Element	Filter element type
Element mat.-no.:	Filter element material number
Min./max. working temperature TS	Min./Max. operating temperature range
Min./max. working pressure PS	Min./max. operating pressure range
Volume	Housing volume
Test Pressure PT	Test pressure
Connection	Thread connections
Pipe NPT 1/2	Thread connection of supply pipe
Drain G 1/2	Thread connection of condensate drain
Fluidgroup 2	Fluid group according to Pressure Equipment Directive 2014/68/EU
PED2014/68/EU / Cat. -	Specification of the category according to Pressure Equipment Directive 2014/68/EU
NOTE	Handling the type plate!
	Never damage, remove or make the type plate illegible.

For more information regarding the symbols printed on the type plate, see “1.4 Explanation of the symbols and pictograms utilised” on Page 5.

4.7 Maintenance label for cartridge replacement

The next due cartridge replacement date is entered on this adhesive label. For this, mark the respective month **[1]** and enter the year accordingly **[2]**.

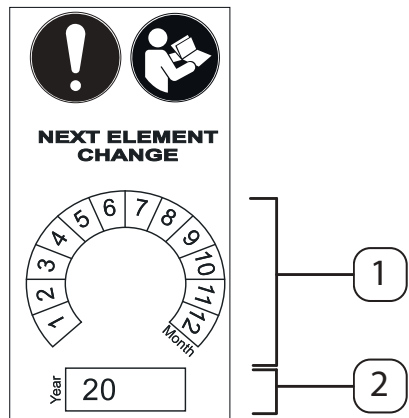

Position no.	Explanation/description
[1]	Specification of month for next cartridge replacement
[2]	Specification of year for next cartridge replacement

5. Technical data

5.1 Filter performance data

CLEARPOINT® V activated carbon filter with cartridge	S055	M010X	M018
Connection [inches]	1/2	3/4	1 1/2
Volume flow at 7 bar(g) energy-optimised [m ³ /h] * ¹	50	100	200
Category according to PED 2014/68/EU	-	-	-
Min./Max. operating pressure [bar(g)] ([psi(g)])	0.3... 16 (4.4 ... 232)		
Min./max. operating temperature [°C] ([°F])	+2 ... +45 (35 ... 113)		
Optimum operating temperature [°C]	25		
Medium	Compressed gases of fluid group 2 according to PED 2014/68/EU free of aggressive and corrosive components		
Cartridge service life [h] ^{*1, *2}	2000	3500	3500
Weight [kg]	1.5	2.5	6
Volume [l]	0.42	1.12	2.97

*¹ Volume flow at 7 bar(g) referring to +20 °C and 1 bar(abs)

*² Service time at +25 °C compressed gas temperature, 30% rel. humidity and max. oil input concentration of approx. 0.08 mg/m³

5.2 Materials

Component	Material	
Housing head	Aluminium, anodised and coated	
Housing body	Aluminium, anodised and coated	
Housing cover	Polyamide and glass fibre	
Housing base	Aluminium, anodised and coated	
M5 screws	Steel, galvanised	
Slide	Zinc with seal FKM	
O-rings	Standard: NBR oil-free: FKM	
Manual condensate drain	Brass, nickel-plated	
Wall bracket	Stainless steel	
Adhesive label	PVC with adhesive	
Oil indicator	See the installation and operating manual for the oil indicator	
Cartridge	Cartridge head	Aluminium
	Rotary separators	Stainless steel
	Cartridge body	Aluminium, anodised
	Cartridge base	Aluminium, anodised
	O-rings	Elastomer
	Filter foam	PUR foam
	ASSY filter element head	Polyamide and glass fibre
	Activated carbon packing	Activated carbon



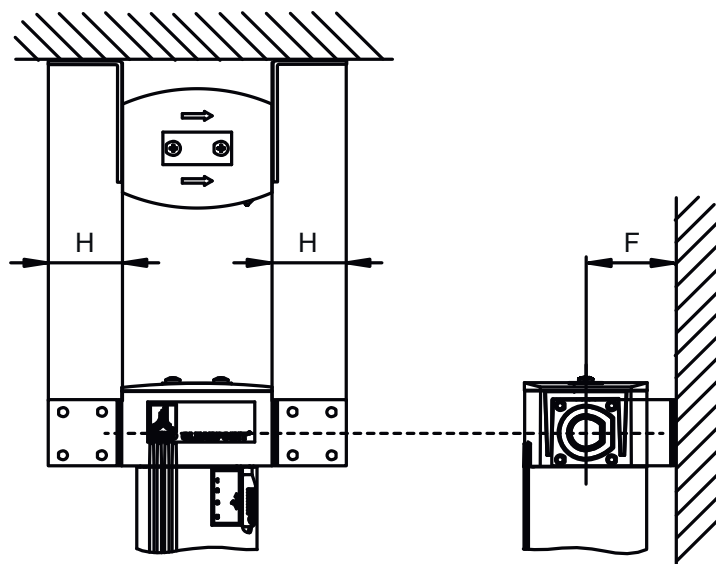
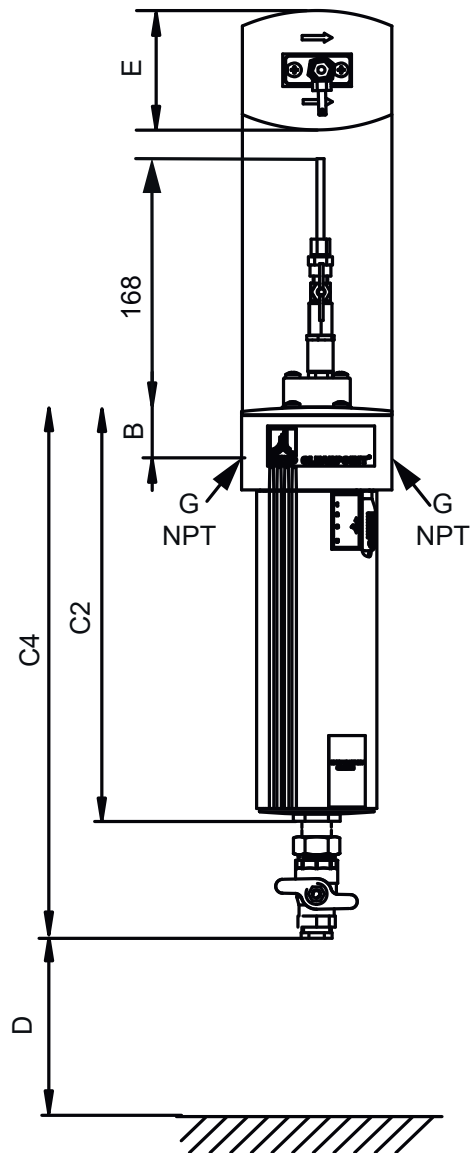

6. Dimensions



Filter	Conne- tion thread	A	B	C2	C3	C4	D	E	F	H	Cartridge
	G / NPT [inches]	[mm]	[mm]	[mm]	[mm]	[mm]	[mm]	[mm]	[mm]	[mm]	
S055 (type)	1/2	75	28	265	293	328	150	60	64.5	39.5	06V
M010X (type)	1	100	34	350	378	413	150	80	63	45	10V
M018 (type)	1 1/2	146	48	418	437	481	160	120	78.5	60	18V

7. Assembly

7.1 Warning notices

DANGER	Use of incorrect spare parts, accessories or installation materials!
	<p>The use of incorrect spare parts, accessories or installation materials, as well as auxiliary and operating materials, may result in death or serious injury. In addition, malfunction and device failure or material damage can occur.</p>
	<ul style="list-style-type: none"> • For all installation, servicing and maintenance work, only use undamaged original parts, auxiliary and operating materials which are specified by the manufacturer. • Only use fittings and connecting elements approved for the respective application as well as suitable tools in perfect operating condition. • Only use pipes that are free of dirt, damage and corrosion.
DANGER	Pressurised system!
	<p>Death or serious personal injury can result through contact with fast or suddenly escaping compressed air or through bursting system parts</p>
	<ul style="list-style-type: none"> • All work on the system must be carried out in the depressurised state and with the system secured against unintentional pressure build-up. • Set up a safety zone around the system during all assembly, installation, maintenance and repair work. • Before applying pressure to the system, check all pipe connections and tighten if necessary. • Slowly pressurise the system with compressed gas. • Avoid pressure blows and high differential pressures. • Assemble all pipes without mechanical stress. Avoid any vibrations occurring in the pipe network by using vibration dampers. • The pipes must be able to bear the additional weight of the filter. Additional fixings must be mounted if necessary. • Always keep exactly to the installation and operating instructions given in this manual. • Always keep inspection and maintenance interval exactly. • Install fixed pipes as supply and discharge pipes. • Do not carry out any structural changes to the product.
WARNING	Insufficient qualification!
	<p>Insufficient qualification of the personnel can lead to accidents, personal injury and damage to the device as well as impairments during work on the product.</p>
	<p>All work on the product may only be carried out by appropriately qualified skilled personnel.</p>
CAUTION	Inappropriate assembly!
	<p>Inappropriate assembly of the product can lead to personal injury and product damage as well as impair operation.</p>
	<ul style="list-style-type: none"> • The direction of flow of the filter must match the direction of flow in the pipe. • The filter must be fitted vertically in the pipe.

7.2 Assembly work

For assembly work to be carried out, the following prerequisites must be fulfilled and the preparatory tasks must have been completed.

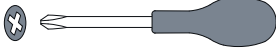
Prerequisites		
Tools	Material	Protective equipment
<ul style="list-style-type: none"> Screwdriver - cross-head size 2.5 mm 	<ul style="list-style-type: none"> Additional installation and operating manual for the accessories used Sealing materials such as e.g. PTFE tape (EN 837-2) 	<ul style="list-style-type: none"> Protective gloves (fluid-resistant) Safety goggles with side shields Hearing protection Respiratory protection, protection class FFP 3 Safety footwear

Preparatory tasks	
1.	Remove the dust cap from the following threads: <ul style="list-style-type: none"> Inlet and outlet on the filter head Condensate drain on the filter base
2.	Depressurise the pipelines or relevant pipe section.
3.	Heed the filter dimensions and make sure there is sufficient space for assembly. See "6. Dimensions" on Page 24.
4.	Pipes must be able to bear the additional weight of the filter. Additional fixings e.g. a wall bracket must be mounted if necessary.
5.	Pipes must be free of contamination and corrosion. Check pipe thread for damage. Defective pipes must be replaced immediately.
6.	Pipes must be free of mechanical stress and corrosion. Compensate any vibrations which occur by using vibration dampers.
7.	Only use fittings which are suitable for this pressure and temperature range. The pipe threads must match those of the filter head.
8.	Execute the condensate drain in such a way that no compressed gas or condensate can escape to the surrounding of the filter.

The direction of flow of the filter must be taken into account during assembly. It must be adapted to the direction of flow in the pipe.

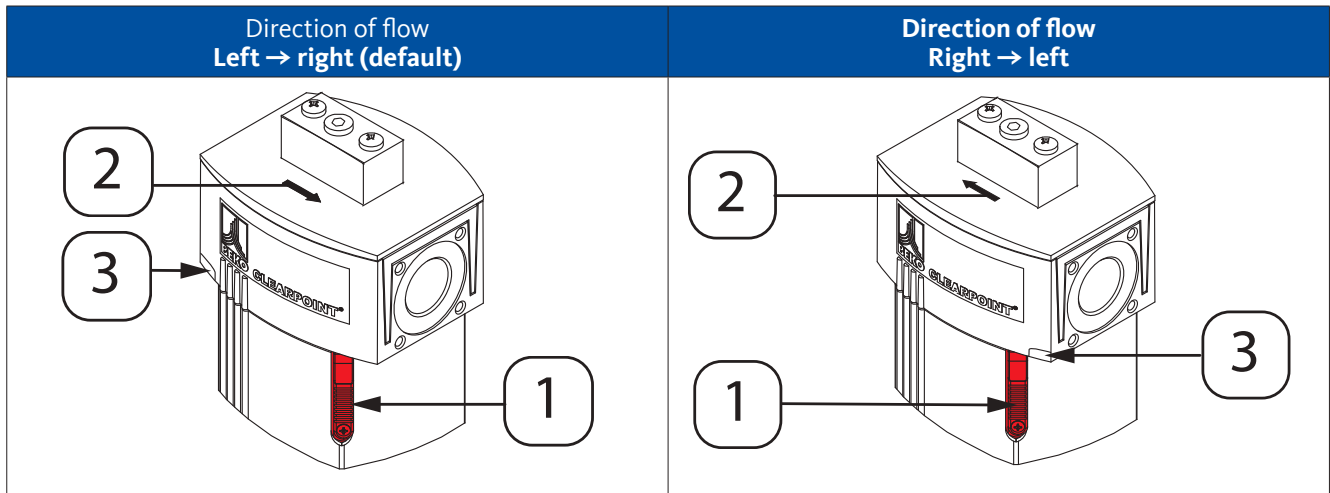

The housing head and the housing body are equipped with a double-start trapezoidal thread. The direction of flow of the filter can be adapted to the direction in the pipe by turning the housing head through 180°. The direction of flow is indicated by arrows [2] and a raised marking [3] on the housing head. These must be aligned as shown. The safety slide [1] must always be in an easily accessible position on the front.

The fitting of a bypass pipe [4] and corresponding shut-off valves [5] is recommended for maintenance and servicing work.

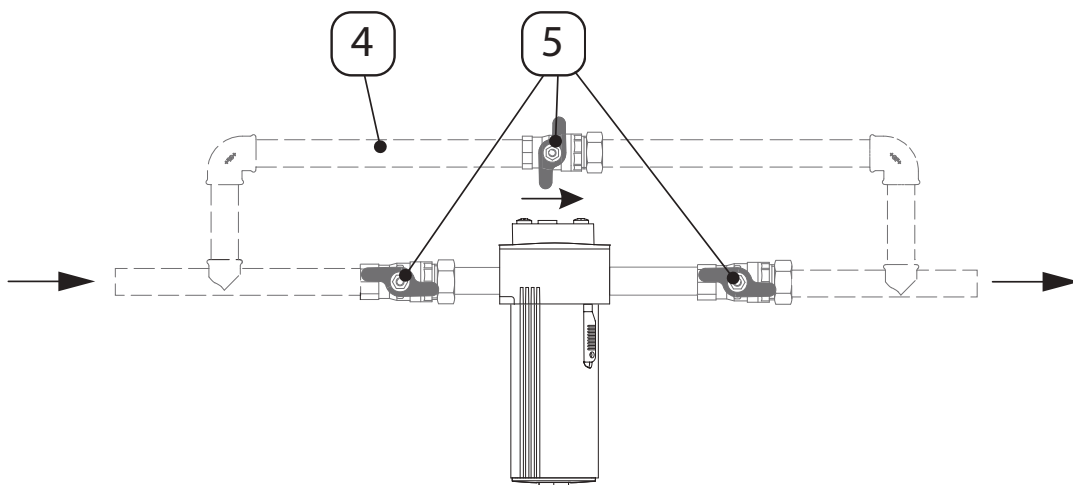

1. Apply sealing material e.g. PTFE-tape (EN 837-2) to the pipe ends
2. Screw the pipe thread into the filter inlet until the connection is firm and leak-tight
3. Screw the pipe thread into the filter outlet until the connection is firm and leak-tight

After assembly work has been finished, it must be checked whether the housing body has been screwed in properly, the safety slide pushed up and the safety screw tightened hand-tight. A leakage test should be carried out to check the assembly work. For additional information, refer to “9.13 Leakage test” on Page 36.

8. Commissioning

8.1 Commissioning tasks

For commissioning to be carried out, the following prerequisites must be fulfilled and the preparatory tasks must have been completed.

Prerequisites		
Tools	Material	Protective equipment
<ul style="list-style-type: none"> • none 	<ul style="list-style-type: none"> • none 	<ul style="list-style-type: none"> • None

Preparatory tasks	
1.	Assembly finished including subsequent leakage test

Illustration	Description
	<ol style="list-style-type: none"> 1. Open the shut-off valve [1] on the inlet side slowly 2. Open the shut-off valve [2] on the outlet side slowly 3. Close the shut-off valve [3] of the bypass pipe



9. Maintenance and servicing

9.1 Maintenance schedule

Maintenance	Interval
Cleaning work	At regular intervals, depending on the degree of contamination
Visual inspection	Weekly
Replacement of the testing tube	In case discolouration is complete
Cartridge replacement	See technical data, for details see 9.5 on Page 32
Leakage test	Recommended interval: At the end of all assembly work and maintenance and servicing work on the product

9.2 Cleaning

9.2.1 Warning notices

CAUTION	Inappropriate cleaning and use of the wrong cleaning media!
	<p>Inappropriate cleaning and the use of the wrong cleaning media may result in minor injuries as well as damage to health and property.</p> <ul style="list-style-type: none"> • Never clean the device with a dripping wet cloth. • Never use abrasive or aggressive cleaning agents or solvents which could damage the outer coating (e.g. labels, type plate, corrosion protection, etc.). • Never clean the device with hard or pointed implements. • For external cleaning, use a dust brush or damp cotton cloths that cannot become statically charged. • Immediately replace product labels (pictograms, markings) that have become illegible.
NOTE	Local hygiene regulations!
	In addition to the cleaning instructions listed, any local hygiene regulations which are in place must be heeded.

9.2.2 Cleaning work

When mounted, the filter is only cleaned on the outside.

For cleaning to be carried out, the following prerequisites must be fulfilled and the preparatory tasks must have been completed.

Prerequisites		
Tools	Material	Protective equipment
<ul style="list-style-type: none"> • none 	<ul style="list-style-type: none"> • Mild detergent • Cotton cloth or disposable tissue 	<ul style="list-style-type: none"> • Protective gloves (fluid-resistant) • Safety goggles with side shields • Hearing protection • Respiratory protection, protection class FFP 3 • Safety footwear

To clean the filter, use a damp (but not wet) cotton cloth or disposable tissue and a mild conventional detergent or soap.

1. Spray a little detergent onto the clean cotton cloth or disposable tissue.
2. Wipe down the entire surface of the component.
3. The final drying is accomplished with a clean cloth or through air drying.

9.3 Visual inspection

During the visual inspection of the filter, all components must be inspected for mechanical damage and corrosion. Any damaged components must be replaced immediately.

9.4 Replacement of the testing tube

For further information on the replacement of the testing tube on the oil indicator, please refer to the installation and operating instructions supplied with the oil indicator.

9.5 Cartridge replacement

For cartridge replacement to be carried out, the following prerequisites must be fulfilled and the preparatory tasks must have been completed.

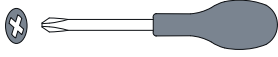
Prerequisites		
Tools	Material	Protective equipment
<ul style="list-style-type: none"> Screwdriver - cross-head size 2.5 mm 	<ul style="list-style-type: none"> New cartridge 	<ul style="list-style-type: none"> Protective gloves (fluid-resistant) Safety goggles with side shields Hearing protection Respiratory protection, protection class FFP 3 Safety footwear

Preparatory tasks	
1.	Open the bypass pipe if available

Life expectation of the cartridge depends on the following parameters:

- Temperature of the compressed air
- Operating pressure of the compressed air
- Volume flow of the compressed air
- Relative humidity of the compressed air
- The oil used
- The compressor design

References for cartridge service lives are:

CLEARPOINT® V activated carbon filter with cartridge	S055	M010X	M018
Cartridge service life [h]*2	2000	3500	3500

The hydrocarbons contained in the compressed air are not completely absorbed by the activated carbon: The absorption capacity for hydrocarbons not only depends on the properties of the activated carbon (raw materials, grain size, pore size, ...) but above all on the structure and polarity of the gas fractions to be absorbed.

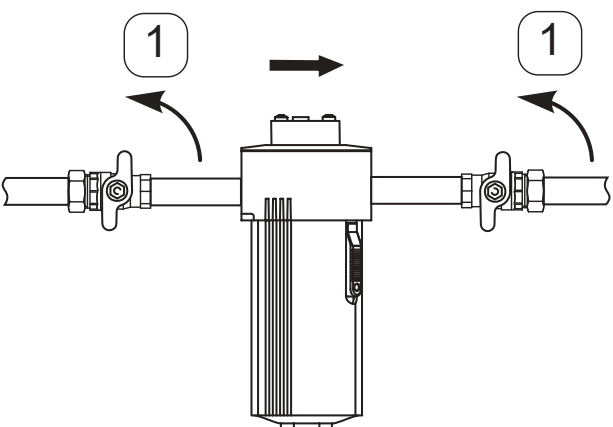
Illustration	Description
	<ol style="list-style-type: none"> 1. Close the shut-off valves upstream and downstream of the filter or the respective system section and depressurise the filter

	<ol style="list-style-type: none"> 2. Undo the locking screw on the safety slide 3. Push the safety slide downwards
	<ol style="list-style-type: none"> 4. Unscrew the housing body 5. Pull the housing body down and off
	<ol style="list-style-type: none"> 6. Pull the used cartridge down and out of the housing head

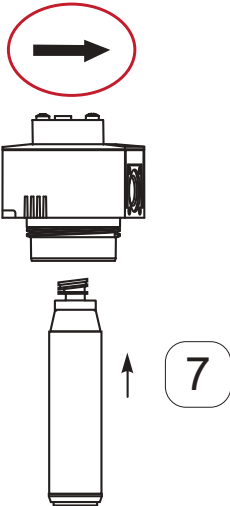
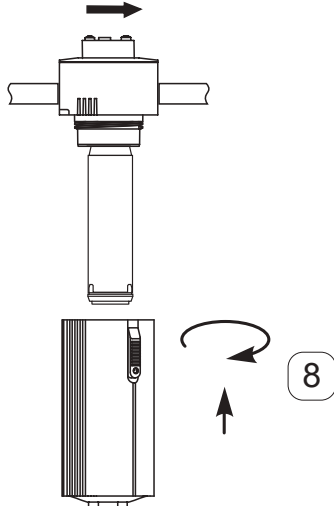
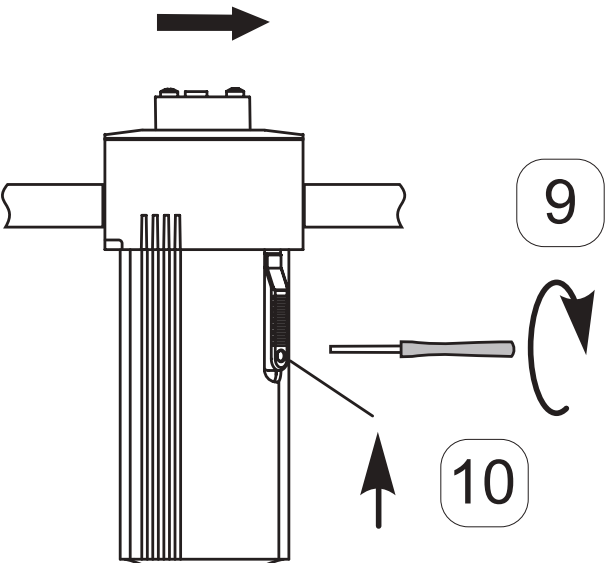
	<p>7. Insert the new cartridge in the housing head as shown.</p>
	<p>8. Screw the housing body to the housing head. Make sure that the safety slide is facing the front.</p>
	<p>9. Push the safety slide upwards. 10. Tighten the locking screw on the safety slide.</p>

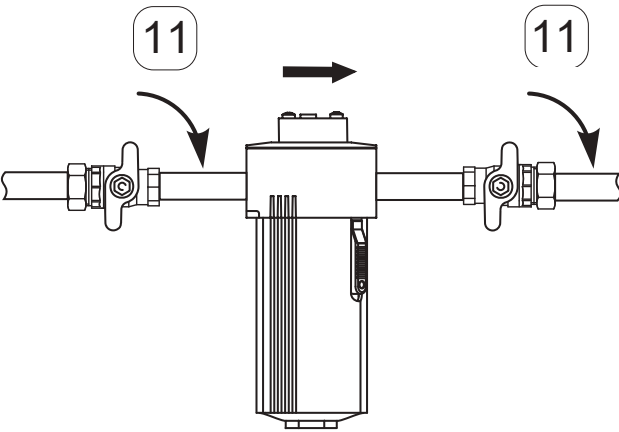
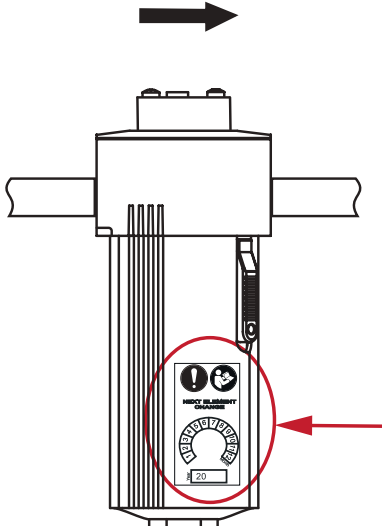
	<p>11. Slowly open the shut-off valves upstream and downstream of the filter or the respective system section.</p>
	<p>12. Attach a new maintenance label on the housing and mark the next maintenance date.</p>

9.13 Leakage test

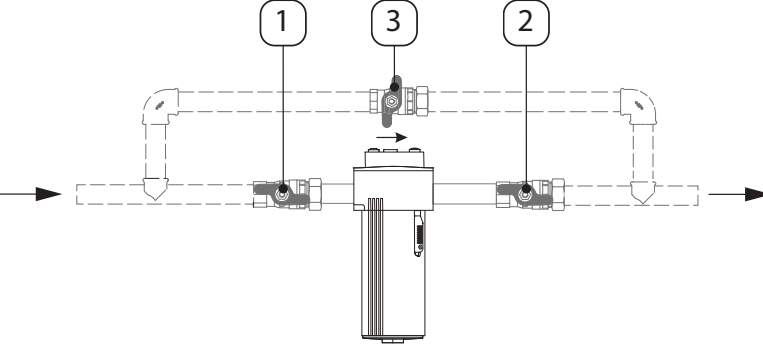

The leakage test is a non-destructive test method and is used to prove leak tightness in vacuum and overpressure systems. The leakage test can be carried out in different ways. The company operating the compressed gas system is responsible for the selection, definition and implementation of the test method to be used, which should be carried out in accordance with valid standards and regulations (e.g. DIN EN 1779).

10. Decommissioning

Illustration	Description
 <p>The diagram shows a side view of a cylindrical activated carbon filter with a bypass pipe. Three shut-off valves are indicated by circled numbers: 1 is on the inlet pipe to the left, 2 is on the outlet pipe to the right, and 3 is on the bypass pipe at the top. Dashed lines and arrows show the flow path: from the inlet through valve 1, either through the filter or the bypass pipe (via valve 3), and then through valve 2 to the outlet.</p>	<ol style="list-style-type: none">1. Open the shut-off valve [3] of the bypass pipe (if available)2. Close the shut-off valve [2] on the outlet side3. Close the shut-off valve [1] on the inlet side

11. Disassembly

11.1 Warning notices

DANGER	Use of incorrect accessories, materials or spare parts!
	<p>The use of incorrect spare parts, accessories or installation materials, as well as auxiliary and operating materials, may result in death or serious injury. In addition, malfunction and device failure or material damage can occur.</p>
	<ul style="list-style-type: none"> • For all disassembly work, only use undamaged original parts, auxiliary and operating materials which are specified by the manufacturer. • Only use fittings and connecting elements approved for the respective application as well as suitable tools in perfect operating condition.
DANGER	Compressed gas
	<p>Death or serious personal injury can result through contact with fast or suddenly escaping compressed air or through bursting system parts</p>
	<ul style="list-style-type: none"> • All work on the system must be carried out in the depressurised state and with the system secured against unintentional pressure build-up. • Set up a safety zone around the system during all assembly, installation, maintenance and repair work. • Before applying pressure to the system, check all pipe connections and tighten if necessary. • Slowly pressurise the system with compressed gas. • Avoid pressure blows and high differential pressures. • Assemble all pipes without mechanical stress. Avoid any vibrations occurring in the pipe network by using vibration dampers. • Always keep exactly to the installation and operating instructions given in this manual. • Always keep inspection and maintenance interval exactly. • Install fixed pipes as supply and discharge pipes. • Do not carry out any structural changes to the product.
WARNING	Insufficient qualification!
	<p>Insufficient qualification of the personnel can lead to accidents, personal injury and damage to the device as well as impairments during work on the product.</p>
	<p>The work on the product described below may only be executed and documented by qualified personnel for compressed gas technology.</p>

11.2 Dismantling work

For disassembly to be carried out, the following prerequisites must be fulfilled and the preparatory tasks must have been completed.

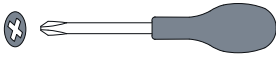
Prerequisites		
Tools	Material	Protective equipment
<ul style="list-style-type: none"> Screwdriver - cross-head size 2.5 mm 	<ul style="list-style-type: none"> none 	<ul style="list-style-type: none"> Protective gloves (fluid-resistant) Safety goggles with side shields Hearing protection Respiratory protection, protection class FFP 3 Safety footwear

Preparatory tasks	
1.	Open the bypass pipe if available

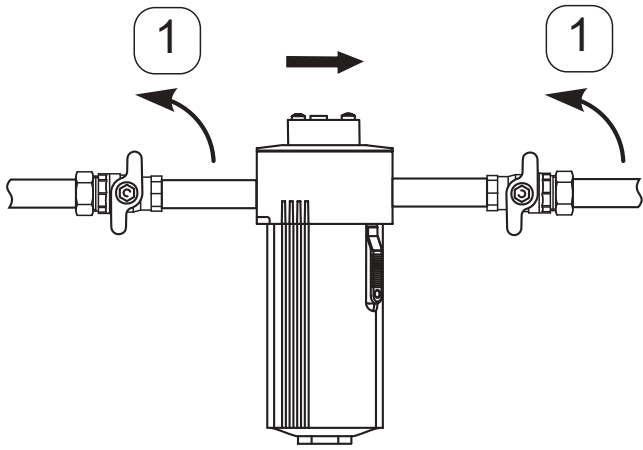
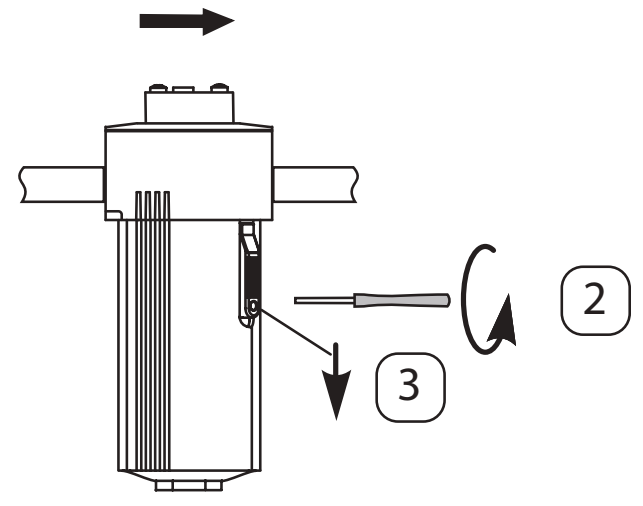
Illustration	Description
	<ol style="list-style-type: none"> 1. Close the shut-off valves upstream and downstream of the filter or the respective system section, depressurise the filter and secure the system against unintentional pressure build-up.
	<ol style="list-style-type: none"> 2. Loosen the locking screw on the safety slide. 3. Push the safety slide downwards.

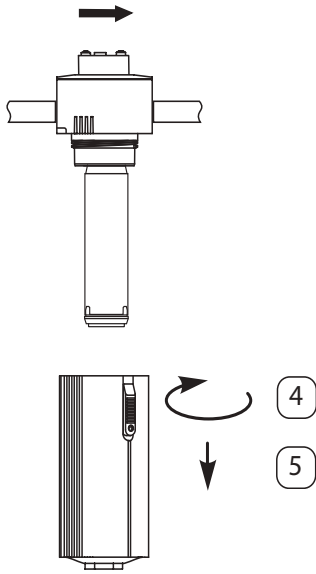



4. Screw the housing body off.
5. Pull the housing body down and off.
Remove the cartridge.

6. Remove the filter head from the pipe and seal the ends of the pipe properly
7. Dispose of the components properly

12. Disposal

12.1 Warning notices

DANGER	Use of incorrect accessories, materials or spare parts!
	<p>The use of incorrect spare parts, accessories or installation materials, as well as auxiliary and operating materials, may result in death or serious injury. In addition, malfunction and device failure or material damage can occur.</p> <ul style="list-style-type: none"> • For all disassembly work, only use undamaged original parts, auxiliary and operating materials which are specified by the manufacturer. • Only use fittings and connecting elements approved for the respective application as well as suitable tools in perfect operating condition.
NOTE	Inappropriate disposal!
	<p>Inappropriate disposal of parts and components, operating and auxiliary materials as well as cleaning media can cause environmental damage.</p> <ul style="list-style-type: none"> • Dispose of all parts and components, operating and auxiliary materials as well as cleaning media professionally and in accordance with regional legal provisions, regulations and requirements. • In case of uncertainties regarding disposal, always consult a regional waste management company.

12.2 Disposal work

At the end of its useful life, the product must be disposed of properly e.g. by a specialist company. Materials such as glass, plastics and some chemical compounds are mostly recoverable, reusable or recyclable.

All national and local regulations must be kept during disposal.



Used activated carbon cartridge:

Waste code: W2030

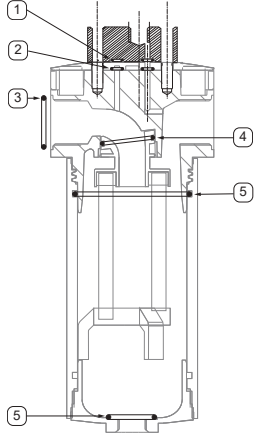

Adsorption and filter materials; cleaning wipes and protective clothing with the exception of those classified by 150202

13. Spare parts and accessories

13.1 Spare parts

Designation	Material no.	Illustration	Separate documentation
O-ring kit for S055	4026562		Enclosed instruction leaflet
O-ring kit for M010X	4026563		
O-ring kit for M018	4026564		
Replacement cartridge, for oil-free application	4009180		None
	4009181		
	4009182		

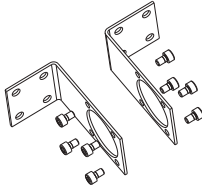
13.2 Accessories attachment components top

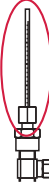
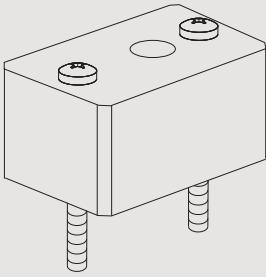
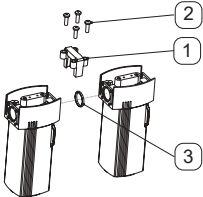
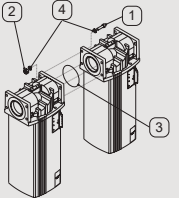
Designation	Material no.	Illustration	Separate documentation
Wall bracket for S055	4003328		None
Wall bracket for M010X	4003329		
Wall bracket for M018	4003330		
Oil indicator with adapter	4008728		Enclosed manual
Replacement tube for oil indicator	4025989		Enclosed instruction leaflet
Adapter for oil indicator or differential pressure gauge S055	4008713		None
Adapter for oil indicator or differential pressure gauge M010X	4008725		
Adapter for oil indicator or differential pressure gauge M018	4008726		
Connection set for S055	4003332		Enclosed instruction leaflet
Connection set for M010X	4003333		Enclosed instruction leaflet
Connection set for M018	4003334		

13.3 Accessories attachment components bottom

Designation	Material no.	Illustration	Separate documentation
Manual condensate drain	2000039		None

14. Troubleshooting / FAQ

Error or fault pattern	Possible causes	Remedy
Poor compressed gas quality	Oil load too high	<ul style="list-style-type: none"> Change operating method Observe the prescribed operating parameters, particularly during start-up processes
	Non-functioning condensate discharge	<ul style="list-style-type: none"> Guarantee regular condensate discharge
	Incorrect dimensioning	<ul style="list-style-type: none"> Dimension the filter according to the given operating parameters and replace if necessary
	Cartridge installed incorrectly	<ul style="list-style-type: none"> Note the direction of flow / direction of installation of the cartridge
	O-ring has been damaged during installation	<ul style="list-style-type: none"> Procure new filter element and O-ring, proceed with care during installation
High differential pressure	Incorrect dimensions	<ul style="list-style-type: none"> Dimension the filter according to the given operating parameters and replace by larger one if necessary
	Excessive soiling of downstream systems	<ul style="list-style-type: none"> Shorten the maintenance interval for cartridge replacement Filtration in stages may be necessary
	Cartridge destroyed	<ul style="list-style-type: none"> Change in operating method Filtration in stages may be necessary
	Fluctuating loads	<ul style="list-style-type: none"> Avoid pressure surges Use storage tank
Condensate in activated carbon filter and/or downstream components	Condensate drain defective or malfunctioning	<ul style="list-style-type: none"> Replace float drain or carry out maintenance on BEKOMAT®
	Cooling downstream of filtration section	<ul style="list-style-type: none"> Drying upstream from the activated carbon filter in system necessary
	Preliminary drying insufficient	<ul style="list-style-type: none"> Check and adapt the design of the dryers upstream of the activated carbon filter.
Leakage	Ageing seals	<ul style="list-style-type: none"> Replace seals within the context of maintenance work
	Mechanical damage	<ul style="list-style-type: none"> Send in the filter for repair or replace by a new one

15. Approval certificates and declarations of conformity

BEKO TECHNOLOGIES GMBH
Im Taubental 7
41468 Neuss

GERMANY

Tel: +49 2131 988-0
www.beko-technologies.com



Herstellererklärung

Wir erklären hiermit, dass die nachfolgend bezeichneten Produkte, in den von uns gelieferten Ausführungen gemäß Druckgeräterichtlinie 2014/68/EU Artikel 4 Absatz 3 in Übereinstimmung mit der geltenden guten Ingenieurpraxis ausgelegt und hergestellt werden.

Produktbezeichnung:	Behälter für Gewindefilter
Typbezeichnung:	CLEARPOINT
Baugröße:	S040, S045, S050, S055, S075, S100, M010, M012, M015, M018
Max. Betriebsdruck:	16 bar
Beschreibung der Druckgeräte:	Druckgeräte für Fluide der Gruppe 2

Druckgeräte nach Artikel 4 Absatz 3 der Druckgeräterichtlinie 2014/68/EU dürfen nicht die in Artikel 19 genannte CE-Kennzeichnung tragen.

Die Behälter wurden einer hydraulischen Druckprüfung mit 23 bar, und einer Dichtheitsprüfung mit dem Medium Druckluft, bei 7,0 bar unterzogen. Bei den durchgeführten Prüfungen zeigten sich keine Mängel.

Neuss, 30.07.2019

BEKO TECHNOLOGIES GMBH

i.V. Christian Riedel
Leiter Qualitätsmanagement International

BEKO TECHNOLOGIES GMBH
Im Taubental 7
41468 Neuss

GERMANY

Phone: +49 2131 988-0
ww.beko-technologies.com



Manufacturer Declaration

We hereby declare that the products indicated hereafter, in the condition in which they have been placed into circulation, have been designed and manufactured according to sound engineering practice, in compliance with Article 4, Paragraph 3 of the European Pressure Equipment Directive 2014/68/EC.

Product designation:	Vessel for threaded filter
Model designation:	CLEARPOINT
Construction size:	S040, S045, S050, S055, S075, S100, M010, M012, M015, M018
Max. operating pressure:	16 bar
Description of the pressure equipment:	Pressure equipment for fluids of Group 2

Pressure equipment according to Article 4, Paragraph 3 of the European Pressure Equipment Directive 2014/68/EC must not bear the CE marking referred to in Article 19 of the above Directive.

The vessel was subjected to a hydraulic pressure test with 23 bar and a leakage test with a compressed air media at 7.0 bar. The vessel passed both tests successfully and no defects were detected.

Neuss, 30.07.2019

BEKO TECHNOLOGIES GMBH

i.V. Christian Riedel
Head of International Quality Management

BEKO TECHNOLOGIES GmbH

Im Taubental 7
 D - 41468 Neuss
 Tel. +49 2131 988 0
 Fax +49 2131 988 900
 info@beko-technologies.com

DE**BEKO TECHNOLOGIES LTD.**

Unit 11-12 Moons Park
 Burnt Meadow Road
 North Moons Moat
 Redditch, Worcs, B98 9PA
 Tel. +44 1527 575 778
 info@beko-technologies.co.uk

GB**BEKO TECHNOLOGIES S.à.r.l.**

Zone Industrielle
 1 Rue des Frères Rémy
 F - 57200 Sarreguemines
 Tél. +33 387 283 800
 info@beko-technologies.fr

FR**BEKO TECHNOLOGIES B.V.**

Veenen 12
 NL - 4703 RB Roosendaal
 Tel. +31 165 320 300
 benelux@beko-technologies.com

NL**BEKO TECHNOLOGIES
(Shanghai) Co. Ltd.**

Rm. 606 Tomson Commercial Building
 710 Dongfang Rd.
 Pudong Shanghai China
 P.C. 200122
 Tel. +86 21 508 158 85
 info.cn@beko-technologies.cn

CN**BEKO TECHNOLOGIES s.r.o.**

Na Pankraci 58
 CZ - 140 00 Praha 4
 Tel. +420 24 14 14 717 /
 +420 24 14 09 333
 info@beko-technologies.cz

CZ**BEKO Tecnológica España S.L.**

Torruella i Urpina 37-42, nave 6
 E - 08758 Cervelló
 Tel. +34 93 632 76 68
 Mobil +34 610 780 639
 info.es@beko-technologies.es

ES**BEKO TECHNOLOGIES LIMITED**

Unit 1010 Miramar Tower
 132 Nathan Rd.
 Tsim Sha Tsui Kowloon Hong Kong
 Tel. +852 5578 6681 (Hong Kong)
 +86 147 1537 0081 (China)
 tim.chan@beko-technologies.com

HK**BEKO TECHNOLOGIES INDIA Pvt. Ltd.**

Plot No.43/1 CIEEP Gandhi Nagar
 Balanagar Hyderabad
 IN - 500 037
 Tel. +91 40 23080275 /
 +91 40 23081107
 Madhusudan.Masur@bekoindia.com

IN**BEKO TECHNOLOGIES S.r.l**

Via Peano 86/88
 I - 10040 Leini (TO)
 Tel. +39 011 4500 576
 Fax +39 0114 500 578
 info.it@beko-technologies.com

IT**BEKO TECHNOLOGIES K.K**

KEIHIN THINK Building 8 Floor
 1-1 Minamiwatarida-machi
 Kawasaki-ku, Kawasaki-shi
 JP - 210-0855
 Tel. +81 44 328 76 01
 info@beko-technologies.jp

JP**BEKO TECHNOLOGIES Sp. z o.o.**

ul. Pańska 73
 PL - 00-834 Warszawa
 Tel. +48 22 314 75 40
 info.pl@beko-technologies.pl

PL**BEKO TECHNOLOGIES S.E.Asia
(Thailand) Ltd.**

75/323 Soi Romklao, Romklao Road
 Sansab Minburi
 Bangkok 10510
 Tel. +66 2-918-2477
 info.th@beko-technologies.com

TH**BEKO TECHNOLOGIES Co.,Ltd**

16F.-5 No.79 Sec.1
 Xintai 5th Rd., Xizhi City
 New Taipei City 221
 Taiwan (R.O.C.)
 Tel. +886 2 8698 3998
 info.tw@beko-technologies.tw

TW**BEKO TECHNOLOGIES CORP.**

900 Great Southwest Pkwy SW
 US - Atlanta, GA 30336
 Tel. +1 404 924-6900
 Fax +1 (404) 629-6666
 beko@bekousa.com

US